

***Argo 8x8***  
***Frontier 650***



***Argo 8x8***  
***Frontier 650***  
**PARTS MANUAL**

From Serial # ...28972

# Foreword

ODG has prepared this parts manual for the 8x8 FRONTIER model to assist both qualified mechanics and vehicle owners in ordering correct, quality replacement ARGO parts. For the most current parts manual visit our website at [www.argoatv.com](http://www.argoatv.com).

Proper and regular service, and replacing old, worn or broken parts with the correct ARGO replacement parts, are both essential to prolonging the life of the ARGO. Please refer to this parts manual and/or our website [www.argoatv.com](http://www.argoatv.com) before ordering any replacement part.

All information contained in this 8x8 FRONTIER Parts Manual is based on the latest product specification available at time of printing. If your 8x8 FRONTIER differs from the specifications contained in this manual, check our website [www.argoatv.com](http://www.argoatv.com) for the most current information.

ODG reserves the right to alter specifications on the 8x8 FRONTIER model at any time, without obligation or prior notification.

Reproduction of this 8x8 FRONTIER Parts Manual, in whole or in part, is prohibited without prior written permission from Ontario Drive & Gear Limited.

## Vehicle Identification

8x8 FRONTIER - Serial Nos. ....28972

## Explanation of Parts Manual Format

<b>Ref</b>	- Reference number between assembly diagram and component parts list
<b>Part No.</b>	- Argo replacement part number for identification and re-ordering
<b>Description</b>	- Part description for identification and re-ordering
<b>Qty</b>	- Indicates the quantity of a part used in an assembly

# Argo 8x8

## Frontier 650



### Using the Parts Manual

1. Find the major vehicle assembly in the Table of Contents on this page, and turn to that section.
2. Locate the part in the illustration that you wish to order.
3. Refer to the parts list in that section.
4. Find the correct part number (Part No.), part description (Description) and correct quantity (Qty).
5. Use *only* this information to order ARGO replacement parts. **DO NOT** attempt to order a replacement part by reference number or page number.

### Table of Contents

Foreword .....	i
Vehicle Identification.....	i
Using the Parts Manual .....	ii
1.0 Transmission .....	1
2.0 Intake and Exhaust System.....	3
3.0 Clutch System .....	5
4.0 Power Pack Assembly .....	7
5.0 Steering & Brake System .....	9
6.0 Parking Brake .....	11
7.0 Vehicle Body & Firewall.....	13
8.0 Frame & Drive System .....	15
9.0 Fuel System & Seat Assembly .....	17
10.0 Electrical System.....	19

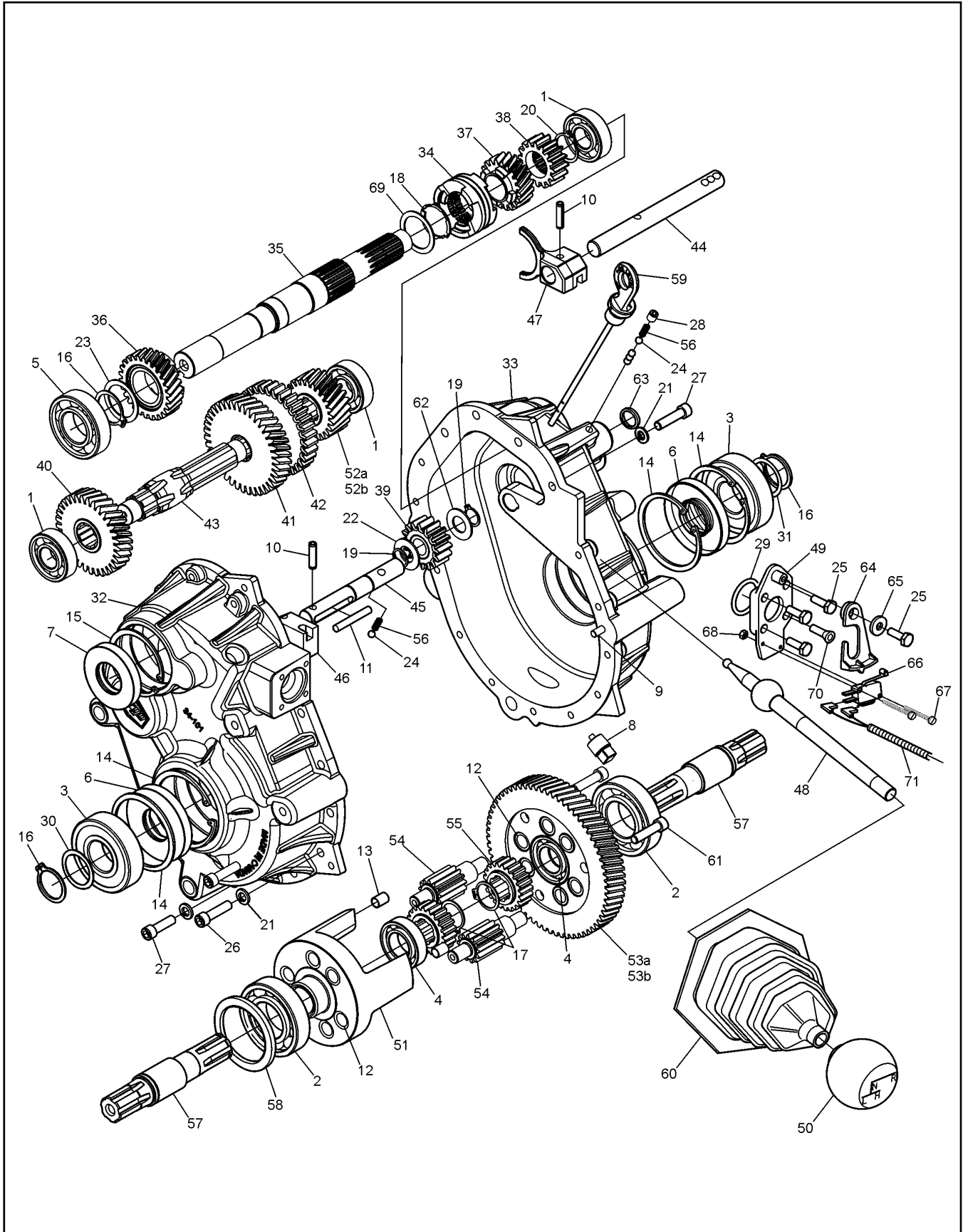

# 8x8 Frontier Parts Manual

# 1.0 Transmission

Ref.	Qty.	Part #	Description	Ref.	Qty.	Part #	Description
	1	34-100	Transmission Assembly	40	1	34-109	Gear, Helical - HI 12DP 33T
	1	34-100-3.3	Transmission Assembly	41	1	34-110	Gear, Helical - LOW 12DP 39T
1	3	101-01	Bearing, Ball 6204Z-C3	42	1	34-111	Gear, Reverse - 10DP 33T
2	2	101-03	Bearing, Ball 6207-C3	43	1	34-112	Shaft, Spline
3	2	101-05	Bearing, Ball 6306LLU-C3/2A	44	1	34-113	Shaft, Shift - Forward
4	2	101-15	Bearing, Ball 6005-C3	45	1	34-114	Shaft, Shift - Reverse
5	1	101-16	Bearing, Ball 6206-C3	46	1	34-115	Block, Shift
6	2	102-03	Seal,Oil WBS 30x72x10 NB D/LIP	47	1	34-116	Fork, Shift
7	1	102-05	Seal,Oil WBS 30x62x10 NB D/LIP	48	1	34-117	Lever, Shift
8	1	103-02	Plug, Magnetic 3/8-18NPT SQ.HD	49	1	34-131	Plate, Shifter
9	2	104-03	Pin, Dowel 1/4x7/8	50	1	34-121	Knob, Shift - w/Argo Logo
10	2	104-39	Pin, Spring - 1/4 x 1.0	51	1	34-122	Cage, Differential
11	1	104-40	Pin, Dowel - 1/4 x 1.75	52a	1	34-123	Pinion, Helical - 25T - 2.6
12	12	105-03	Bushing, Oilite - 1/2x3/4	52b	1	34-125	Pinion, Helical - 21T - 3.3
13	3	105-23	Bushing, Dowel - .312 x .5	53a	1	34-124	Gear Plate - 66T - 2.6
14	4	106-03	Retaining Ring HO-281PA	53b	1	34-126	Gear Plate - 70T - 3.3
15	1	106-05	Retaining Ring HO-244-PA	54	6	34-13	Gear, Planet - 12T
16	3	107-02	Retaining Ring SH-0118-PA	55	2	34-14	Gear, Sun - 21T
17	2	107-04	Retaining Ring SH-0098-PA	56	2	34-32	Spring, Comp. 0.22x.50
18	1	107-14	Retaining Ring LC-125-PA	57	2	34-98	Shaft, Output - Splined
19	2	107-11	Retaining Ring	58	1	114-01	Washer, Shim 2.25 x 2.81 x .02
20	1	107-15	Retaining Ring SHR-098-PA	59	1	CE-035	Dipstick - with Breather - 190mm
21	15	108-05	Lockwasher 5/16 Split Ring Zn	60	1	609-38	Boot, Shifter
22	1	108-78	Washer, Thrust	61	3	112-64	SHCS, 5/16-18 x 1.25
23	1	108-79	Washer, Thrust	62	1	108-88	Washer, Retaining Thrust
24	5	109-05	Ball, Steel 6mm 62-67 Rc	63	1	113-16	O-Ring #AS568-014-70BN 5/8"OD x 1/2"ID x 1/16" Thk
25	4	112-04	HHCS 1/4-20x3/4 Gr2 Zn	64	1	34-132	Follower, Neutral Start
26	14	112-143	SHCS 5/16 x 1.25 Zn	65	1	108-08	Washer, .28 x .62 x .07 Zn
27	1	112-144	SHCS 5/16 x 1.0 Zn	66	1	809-202	Switch, Limit - Two Pole
28	1	112-145	SHSS 5/16 - 18 X 3/8	67	2	112-172/PI	SHMS, #5-40x3/4 Zn
29	1	113-11	O-Ring #AS568-216-70BN	68	2	112-173/PI	Locknut, #5-40 Zn
30	1	114-04	Washer, Shim 1.19x1.50x.04	69	1	108-85	Washer, Retaining Thrust
31	1	114-05	Washer, Shim 1.19x1.50x.02	70	1	112-171	FHSC 1/4-20 x 3/4 Gr2 Zn
32	1	34-101	Housing, Transmission - L	71	1	613-112	Wire Harness, Neutral Start
33	1	34-102	Housing, Transmission - R				
34	1	34-127	Clutch, Dog				
35	1	34-130	Shaft, Input - 19/15T Spline				
36	1	34-128	Pinion, Helical - HI 12DP 26T				
37	1	34-129	Pinion, Helical - LO 12DP 20T				
38	1	34-107	Pinion, Reverse - 10DP 16T				
39	1	34-108	Gear, Idler - Rev - 10DP 16T				

# 2.0 Intake and Exhaust System 8x8 Frontier Parts Manual

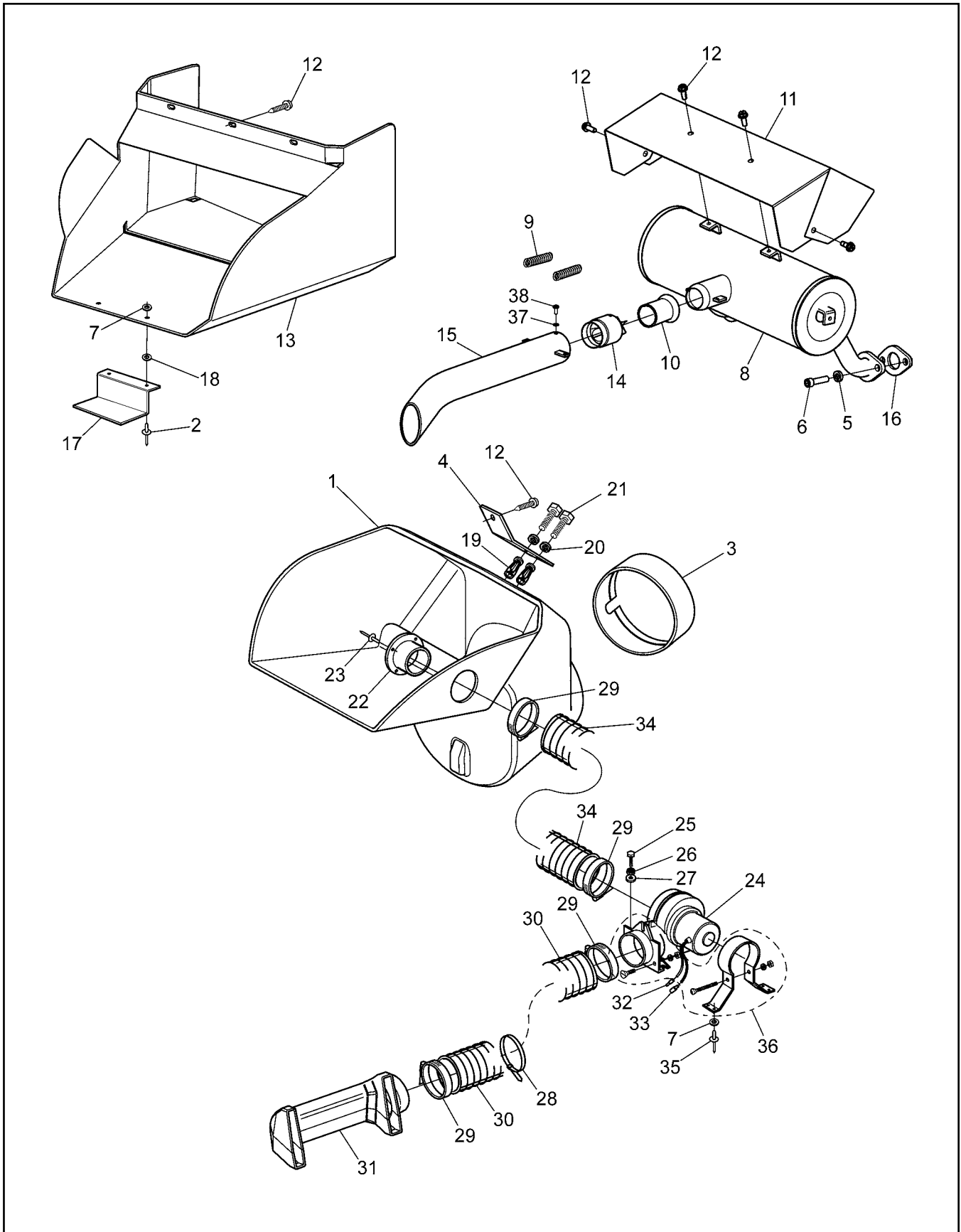

# 8x8 Frontier Parts Manual 2.0 Intake and Exhaust System

Ref.	Qty.	Part #	Description
1	1	809-07	Duct, Intake - Frontier
2	2	120-31	Rivet, 3/16 x 1/4". Open End
3	1	603-82	Seal
4	1	809-08	Bracket, Intake Duct
5	4	108-02	Lockwasher 5/16 Hi-Collar Bare
6	4	112-30	SHCS M8 x 1,25 x 20mm Zn
7	6	120-04	Washer, .19 x .50 x .08 Zn
8	1	807-135	Muffler, B&S 23HP Weld Ass'y
9	2	127-187	Spring, Extension - 17/32 x 3.75
10	1	607-135	Tube Ass'y, Muffler, Flared
11	1	607-123	Shield, Heat - Muffler
12	8	112-19	Screw, IHWH T/C Slot 1/4-20 x 1/2
13	1	607-129	Duct, Exhaust
14	1	607-126	Spark Arrester, 1.75 Dia.
15	1	607-134	Pipe, Tail - Ass'y Lg.
16	2	806425	Gasket, Exhaust, B&S 23 HP
17	1	707-45	Support, Exhaust Duct
18	2	125-58	Washer, Fibre - W-77F
19	2	117-53	Nut, Jack 1/4-20 8L-JNS Zn
20	2	108-03	Lockwasher 1/4 Split Ring Zn
21	2	103-97	HHCS 1/4-20 x 1.25 Gr5 Zn
22	1	127-171	Adapter, 3" Hose
23	4	120-11	Rivet, 5/32 x 9/16 Black
24	1	125-91	Blower Fan
25	4	103-47	HHCS, #10-24 x 1/2
26	4	120-05	Washer, .19 x .50 x .04
27	4	108-59	Lockwasher #10 Int. Tooth
28	1	100-102	Tie Wrap, 14" - White
29	4	125-35	Clamp, Gear 3.50" HF-52
30	1	127-139	Hose, Brake Fan Discharge
31	1	127-134	Duct, Brake Cooling
32	1	118-02	Terminal, Male #76-1251
33	1	118-03	Terminal, Female #76-1289
34	1	127-140	Hose, Brake Fan Inlet
35	4	120-09	Rivet, 3/16 x 1.0 Black
36		125-92	Adpt. & Mounting Kit - includes the following:
	1		Mounting Bracket
	1		Nut, #10-32
	1		Lockwasher, 3/16"
	1		Screw, #10-32x2"
	2		Nut, 1/4-20
	2		Lockwasher, 1/4"
	2		Screw, 1/4-20x5/8"
	1		Adaptor, 3" dia.
37	1	108-71	Lockwasher, #8 External Tooth
38	1	112-43	Screw IHWH #8 x 3/8

# 3.0 Clutch System

# 8x8 Frontier Parts Manual

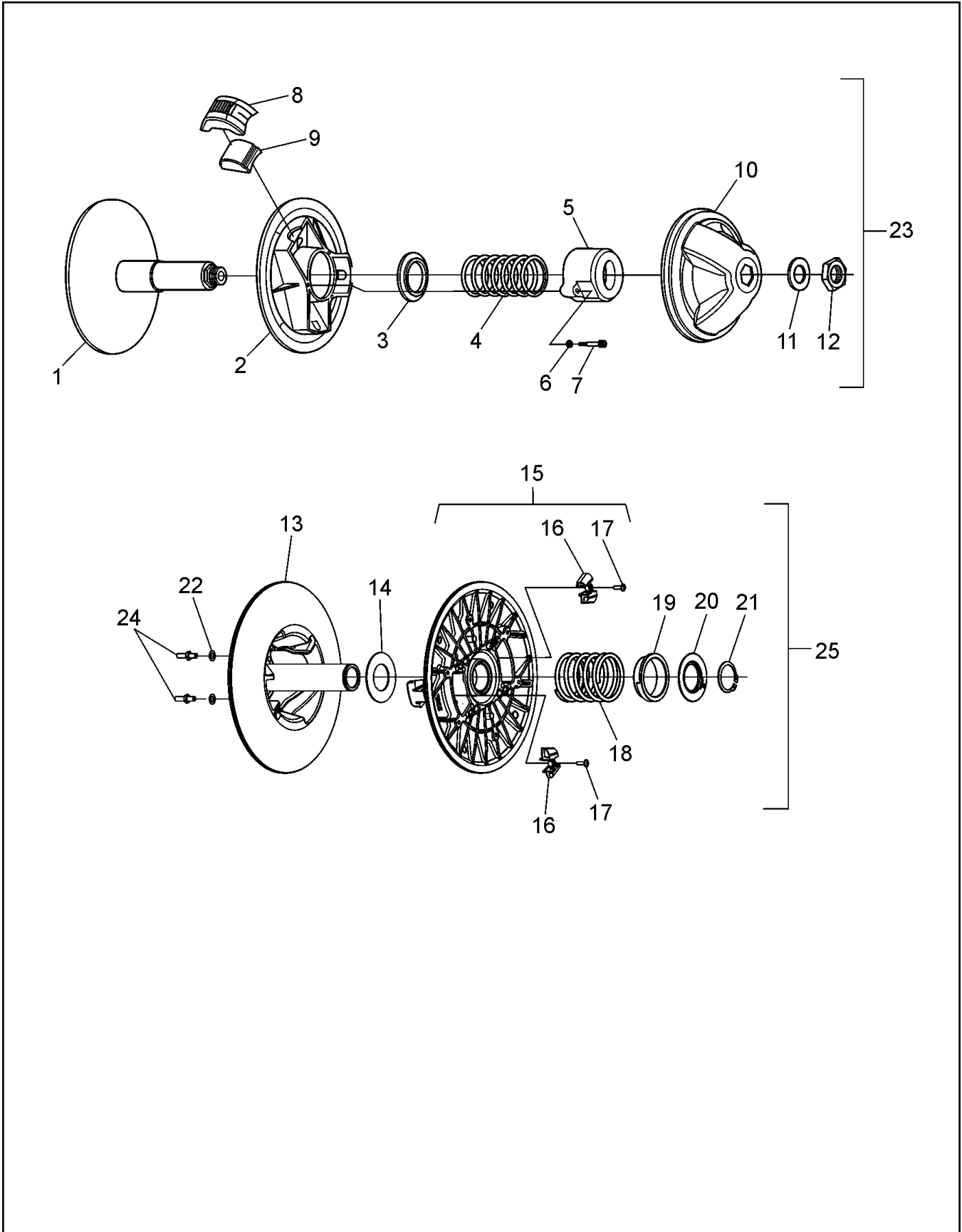

Ref.	Qty.	Part #	Description
1	1	0405-0075	Flange, Fixed
2	1	0410-0026	Flange, Sliding
3	1	0150-1014	Spring Guide Washer
4	1	0451-1114	Spring
5	1	0440-0005	Spring Cover
6	3	0080-0167	Lockwasher
7	3	0080-0021	Screw, Cap
8	3	0130-3009	Block
9	3	0135-3065	Weight (275gr)
10	1	0115-0047	Cap
11	1	0080-0153	Washer, Zn
12	1	0080-0100	Nut
13	1	5905-0003	Flange, Fixed
14	1	0080-0164	Washer, Shim
15	1	5910-0002	Flange, Sliding
16	3	5930-3001	Cam Shoe
17	2	0080-0031	Screw
18	1	5951-1009	Spring
19	1	5950-3003	Spring Protector
20	1	5950-3002	Spring Support
21	1	0080-0216	Retaining Ring, Outside
22	2	0080-0167	Lockwasher
23	1	127-135	Clutch, Driver
24	2	0080-0035	Screw & Nut Ass'y
25	1	127-156	Clutch, Driven - INVANCE

# 4.0 Power Pack Assembly

# 8x8 Frontier Parts Manual

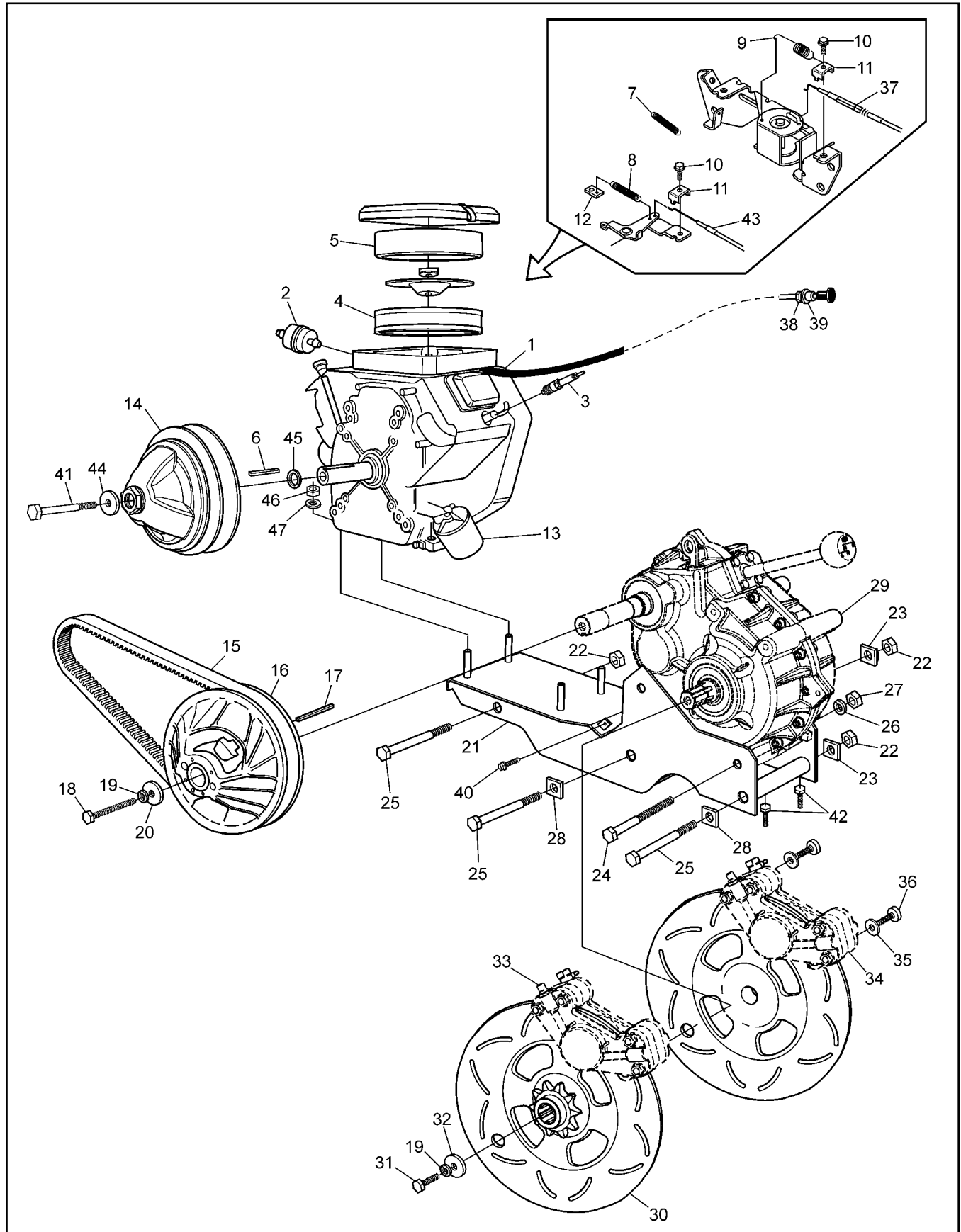

# 8x8 Frontier Parts Manual

# 4.0 Power Pack Assembly

Ref.	Qty.	Part #	Description
1	1	128-20	Engine - B&S 23HP, 20/50 amp incl. Ref. 2-13 B&S #386447-0144-E1
2	1	125-64	Fuel Filter, G81-4
3	2	127-193	Sparkplug RC14YC
4	1	692519	Filter, Air
5	1	692520	Element, Foam
6	1	110-18	Key 1/4 x 1/4 x 1.75 RC45
7	1	805458	Spring
8	1	125-88	Spring, Return
9	1	127-49	Spring, Return
10	2	805169	Screw-Hex Head (Briggs #)
11	2	221535	Clamp - Casing (Briggs #)
12	1	601-86	Clip, Retainer
13	1	126-95	Filter, Oil
14			<b>See Section 3.0 Clutch System</b>
15	1	127-159	Drive Belt - Frontier - 11.3" Cen. Dist
16			<b>See Section 3.0 Clutch System</b>
17	1	110-03	Key 1/4 x 3/16 x 2.375 RC46
18	1	112-164	HHCS 3/8-16 x 3.50 Gr5 Zn
19	3	108-06	Lockwasher 3/8 Split Ring Zn
20	1	108-46	Washer .40 x 1.37 x 1.2 Hi-Carbon
21	1	604-118	Frame Ass'y - Power Pack
22	3	117-83	Locknut, Stover 5/8-11 Zn
23	2	811-09	Washer, Square - .64 ID
24	2	103-20	HHCS 1/2-13 x 6.5 Gr5 Zn
25	3	112-58	HHCS 5/8-11 x 7.5 Gr5 Zn
26	2	108-07	Lockwasher 1/2 Split Ring Zn
27	2	117-06	Nut, Fin Hex 1/2-13 Zn
28	2	811-15	Washer, Square Lock .64 ID
29			<b>See Section 1.0 Transmission</b>
30	2	606-74	Disc, Brake-Splined #60-10T
31	2	103-18	HHCS 3/8-24 x 1.25 Gr5 Zn
32	2	108-18	Washer .40 x 1.37 x .12 Zn
33			<b>See Section 5.0 Steering &amp; Brake System</b>

Ref.	Qty.	Part #	Description
34			<b>See Section 5.0 Steering &amp; Brake System</b>
35	4	108-23	Washer .42 x .81 x .06 Gr8 Zn
36	4	103-41	SHCS 3/8-16 x 1.25 Zn
37	1	612-101	Cable Asm, Throttle
38	2	117-68	Nut, Jam 3/8-24 UNF Zn
39	1	108-32	Lockwasher 3/8 Int.Tooth
40	2	103-71	Screw, IHWH T/C 1/4-20 x 1.25
41	1	112-160	HHCS, 7/16-20 x 5" Lg
42	2	103-53	HHCS 3/8-16 x 3.0 Full Thread
43	1	612-130	Cable Asm, Choke
44	1	108-58	Washer .47 x 1.37 x .12 Hi-Carbon
45	1	108-84	Washer, Engine, Clutch
46	4	117-21	Locknut, Nylon 5/16-18 Zn
47	4	108-24	Washer .34 x 1.00 x .06 Zn

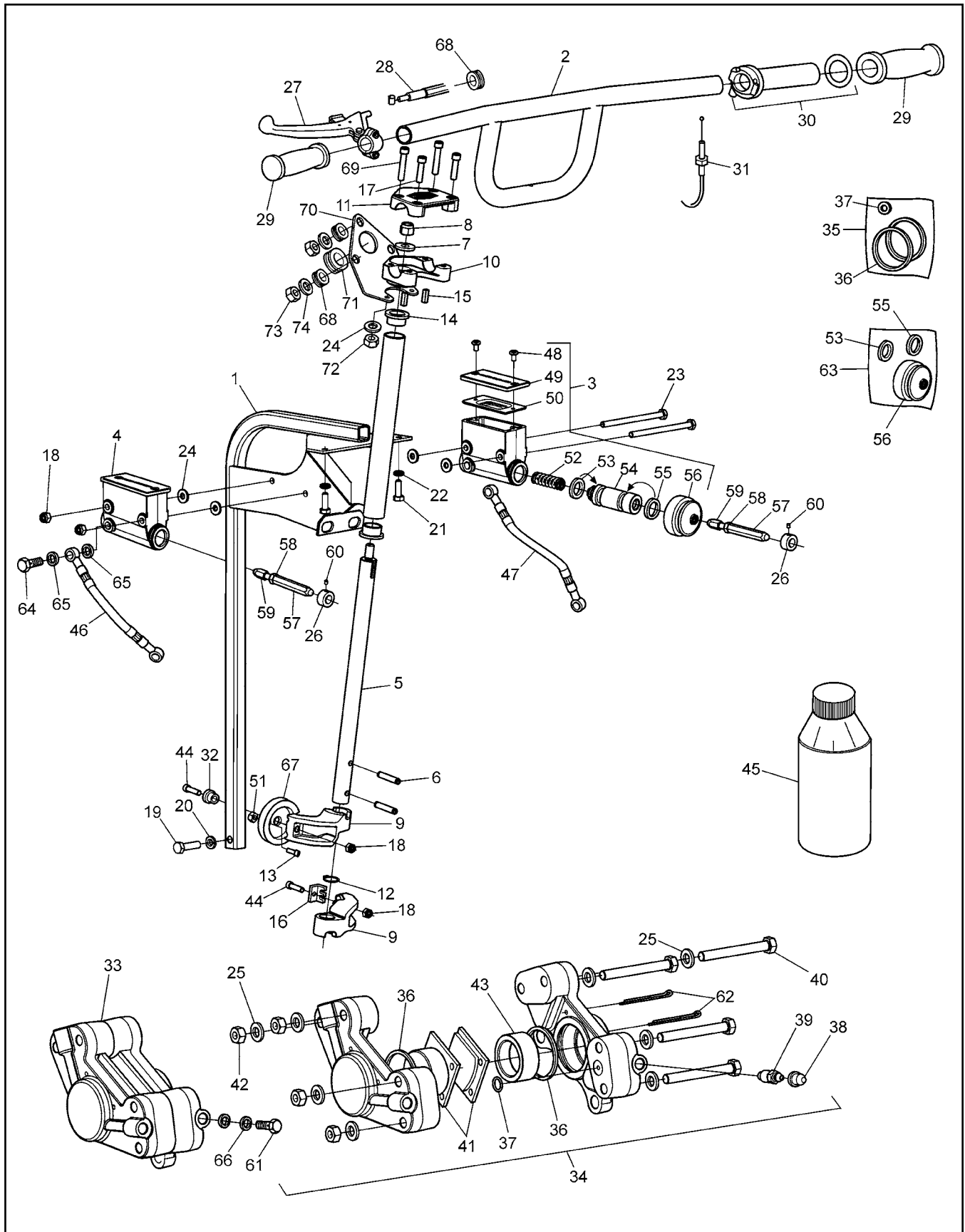

# 8x8 Frontier Parts Manual

# 5.0 Steering & Brake System

Ref.	Qty.	Part #	Description	Ref.	Qty.	Part #	Description
1	1	612-123	Frame Assembly, Steering Column	44	2	112-159	BHCS, 1/4-20 x 1.0, Plated
2	1	612-107	Handlebar Assembly	45		126-19	Fluid, Brake-Silicon Dot 5 - .35L
3	1	165-08	Master Cylinder, Grimeca - R	46	1	163-05	Hose Asm, Hydraulic - Left
4	1	165-07	Master Cylinder, Grimeca - L	47	1	163-06	Hose Asm, Hydraulic - Right - SS
5	1	612-128	Shaft, Steering - Avenger	48	2x2	160-42	Screw, FHMS M5 x 0,8 x 6mm
6	2	104-42	Pin, Spring 1/4 x 1.5"	49	2x1	168-08	Cover
7	1	108-47	Washer, .39 x .94 x .13 Zn Di-chr	50	2x1	168-09	Cover, Rubber
8	1	117-29	Locknut, Nylon 3/8-16 Zn	51	1	117-10	Locknut, 10-24 N/I Zn
9	2	612-124	Arm, Steering	52	2x1	162-08	Spring, Comp. 17.3 x 49.3mm
10	1	612-106	Clamp, Lower Handlebar	53	2x1		Seal, Primary, 19mm (See Ref. 63)
11	1	612-105	Clamp, Upper Handlebar	54	2x1	168-10	Piston 19mm dia.
12	1	106-07	Ring, Retaining SH-0075PA	55	2x1		Seal, Secondary, 19mm (See Ref. 63)
13	1	160-46	SHCS, #10-24 x 3/8"	56	2x1		Boot, Rubber (See Ref. 63)
14	2	105-16	Bushing, Oilite - 3/4 x 1/2	57	2	812-30	Pin, Female
15	2	110-17	Key, 3/16 x 3/16 x .625	58	2	117-03	Nut, Fin Hex 1/4-20 Zn
16	1	128-24	Retainer, Handbrake Cable	59	2	812-31	Fin, Male
17	2	112-47	SHCS, 1/4-20 x 1.0 Zn	60	2	112-02	SHSS 10-24x1/4 Knurl Cup PT, PL
18	4	117-27	Locknut, Nylon 1/4-20 Zn	61	2	160-45	Bolt, Banjo
19	1	103-38	HHCS 5/16-18 x 1.25 Gr5 Zn	62	2x2	168-07	Pin, Cotter 1/8 x 3.00 Zn
20	1	108-05	Lockwasher 5/16 Split-Ring Zn	63	2x1	161-25	O-Ring Kit - Master Cylinder - Grimeca (incl. Ref. 53, 55 & 56)
21	2	112-04	HHCS 1/4-20 x 3/4 Gr2 Zn	64	2	160-44	Bolt, Banjo - M10 x 1,0 x 21,0
22	2	108-03	Lockwasher 1/4 Split Ring Zn	65	4	160-01	Washer, Copper - 1,5 x 10,0 x 14,0
23	2	103-66	HHCS, 1/4-20 x 4.0 Gr5 Zn	66	4	160-04	Washer, Copper 2.3 x 10,0 x 16.0
24	4	108-08	Washer, .28 x .62 x .04 Zn	67	1	165-18	Pulley, Handbrake Cable
25	2x8	108-24	Washer, .34 x .70 x .06 Zn	68	4	125-84	Grommet, Rubber
26	2	812-17	Collar	69	2	103-69	SHCS 1/4-20 x 1.5 Zn
27	1	128-17	Lever Assembly, Handbrake, Spring	70	1	612-132	Bracket, LCD Gauge - Painted
28	1	128-21	Cable Assembly, Handbrake	71	1	128-27	Grommet 1-1/4ID x 1-1/2x3/32
29	2	127-35	Grip, Molded	72	2	117-86	Nut, Acorn, 1/4-20 Zn
30	1	127-81	Throttle Twist Grip	73	3	117-85	Nut, Acorn, M5 Zn
31	1	612-116	Cable Asm., Throttle	74	3	120-04	Washer .19 x .50 x.08 Zn
32	1	105-25	Bushing, Flange Oilite FF-310				
33	1	166-10	Caliper, Hydraulic Brake - L w/o pads				
34	1	166-11	Caliper, Hydraulic Brake - R w/o pads				
35	2	161-05	O-ring Kit, Knott Caliper				
36	2		Seal, Piston				
37	2		Seal, Rubber				
38	2x1	168-20	Plug, Rubber				
39	2x1	168-02	Screw, Bleeding, Knott Caliper				
40	2x4	112-154	SHCS, 5/16-18 x 2.75 Zn				
41	1	170-03	Pad Set (4), Brake - Non-Asbestos				
42	2x4	117-03	Nut, Fin Hex 5/16-18 Zn				
43	2x2	168-01	Piston, Knott Caliper				

# 6.0 Parking Brake

# 8x8 Frontier Parts Manual

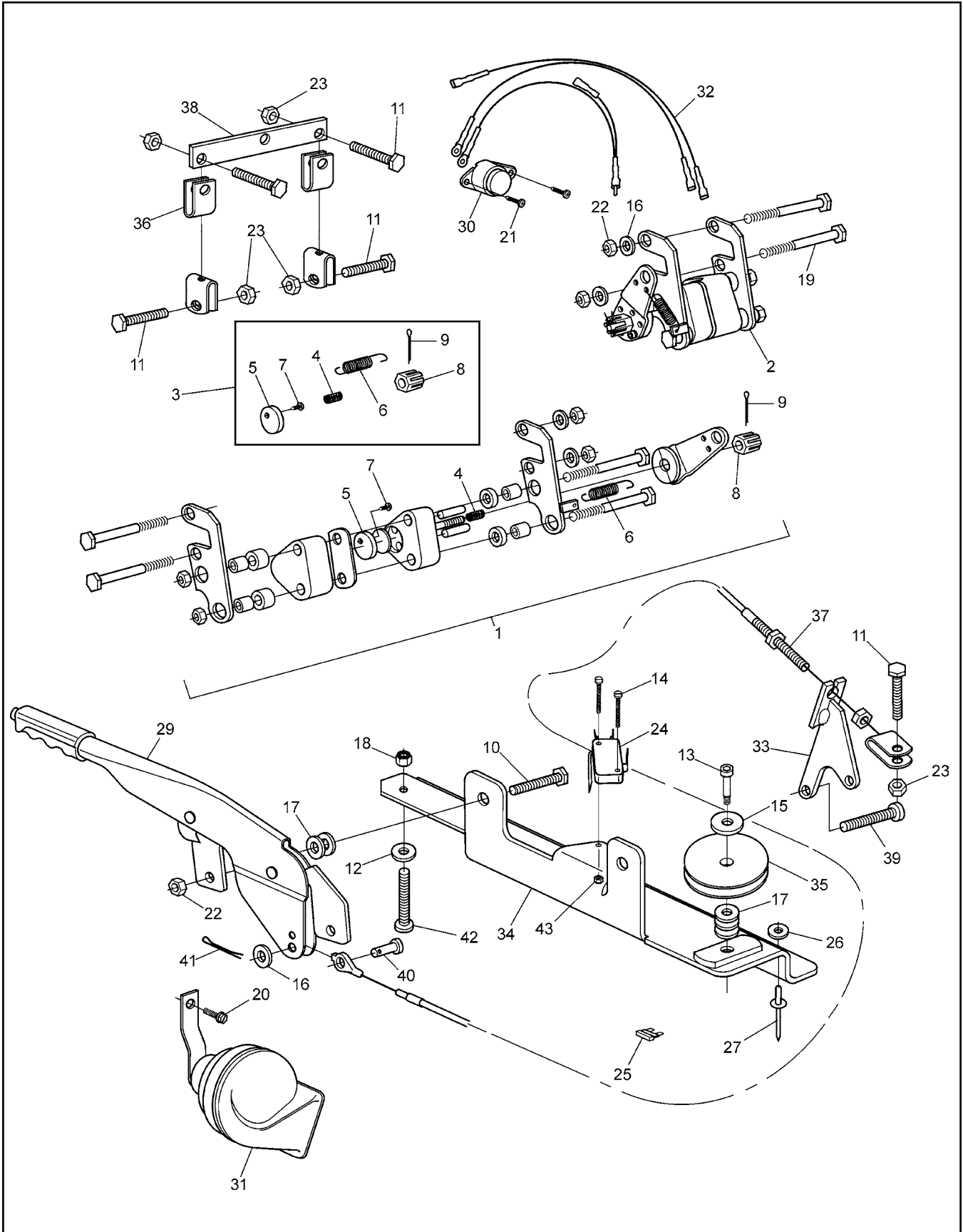

Ref.	Qty.	Part #	Description
1	1	850-96	Caliper Ass'y, LH, Parking Brake
2	1	850-97	Caliper Ass'y, RH, Parking Brake
3	1	850-98	Kit, Service, Parking Brake (includes Ref. 4 - 9, not sold separately)
4	1		Cam Tension Spring (compression)
5	1		Left & Right Brake Pads
6	1		Cam Arm Spring (tension)
7	1		Brake Pad Retaining Screw
8	1		Castle Nut
9	1		Cotter Pin
10	2	103-06	HHCS 5/16-18x1.0 Gr5 Zn
11	5	103-08	HHCS 1/4-20x1.0 Zn
12	1	108-42	Washer .21x1.0x.06 Zn
13	1	112-178	Bolt, Shoulder, 1/2 x 5/8
14	2	112-172	SHCS 5-40 x 3/4 Zn
15	1	108-41	Washer .53 x 1.09 x .12 Plain
16	5	108-24	Washer .34x.70x.06 Zn
17	7	108-47	Washer .39x.94x.13 Zn Di-Chro
18	1	117-10	Locknut, 10-24 N/I Zn
19	4	112-132	HHCS 5/16-18 x 3.25 Gr5 Zn
20	1	112-19	Screw,IHWH T/C Slot 1/4-20x1/2*
21	2	112-56	T/S Pan Head Phil #10x3/4 A Zn*
22	6	117-21	Locknut, Nylon 5/16-18 Zn
23	5	117-27	Locknut, Nylon 1/4-20 Zn
24	1	613-120	Switch, Micro, Lever
25	1	118-52	Fuse, 10A 2-Prong (AT010)*
26	4	120-04	Washer .19x.50x.08 Zn
27	4	120-09	Rivet - 3/16 x 1.0 Black
29	1	809-147	Lever, Parking Brake
30	1	848-86	Button, Horn*
31	1	848-87	Horn, Electric*
32	1	848-88	Wire Harness, Horn*
33	1	850-72	Bracket Asm, Parking/Brake
34	1	850-78	Bracket, Parking Lever
35	1	850-79	Pulley, Parking Brake Cable
36	2	850-80	Cable, Parking Brake Equalizer
37	1	850-81	Cable, Parking Brake
38	1	850-82	Flat Bar, Equalizer
39	1	112-143/PI	SHCS 5/16x1.25 Zn
40	1	104-27	Pin, Clevis 5/16x.75" Zn
41	1	100-100	Pin, Cotter 1/8x3/4 Zn
42	1	112-174	RHMS 10-24 x 1.75 Zn
43	2	112-173	Locknut, #5-40, Zn
			*If equipped

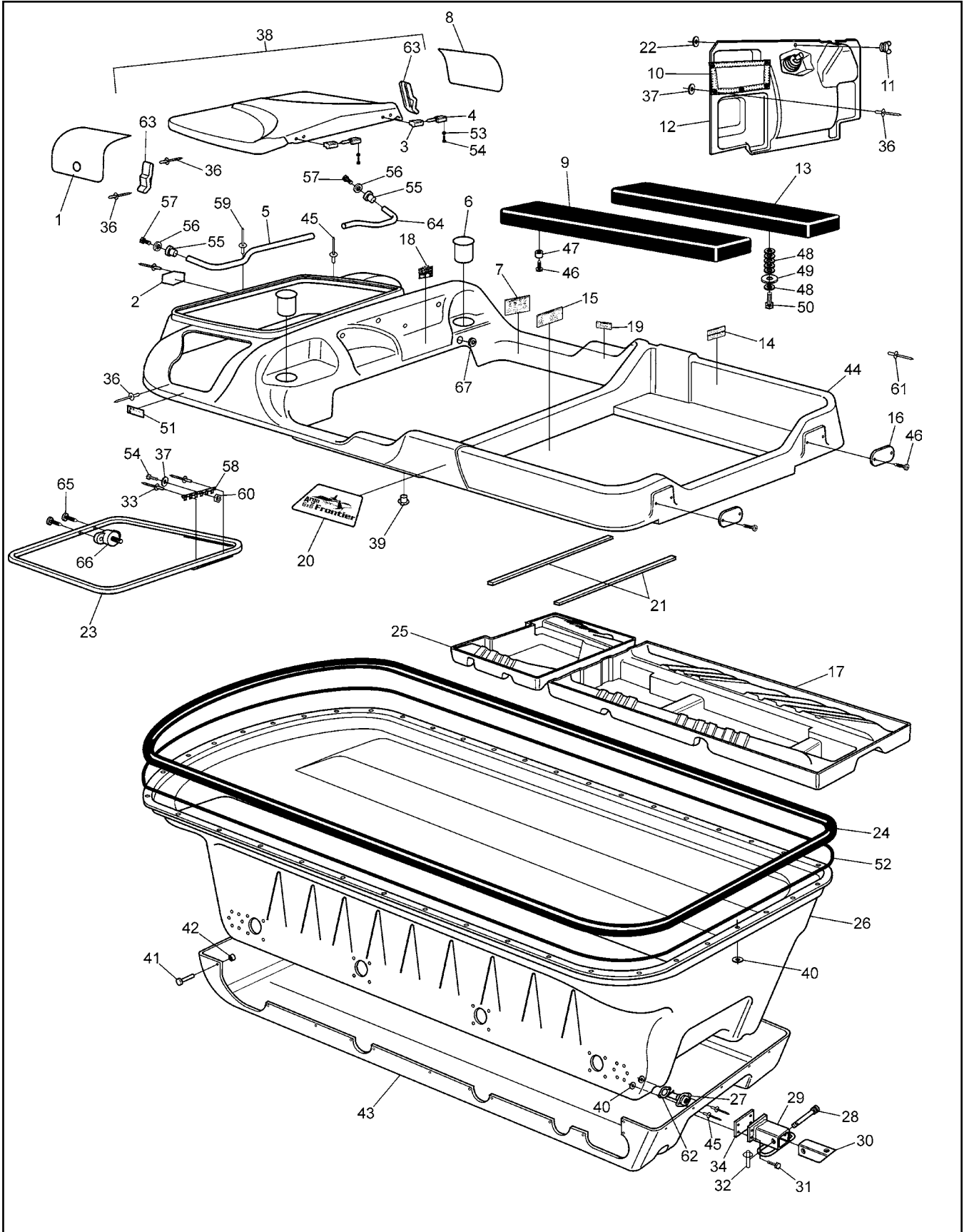

## 8x8 Frontier Parts Manual

## 7.0 Vehicle Body & Firewall

Ref.	Qty.	Part #	Description	Ref.	Qty.	Part #	Description
1	1	707-43	Screen - Exhaust	41	32	120-27	Pin, Magna Grip
2	1	601-44	Nameplate, "Argo"	42	32	120-28	Collar, Magna Grip
3	2	127-45B	Knuckle, Hinge	43	1	801-51	Skid Plate - Black (Opt.)
4	2	127-45A	Pin, Hinge	44	1	801-53	Body & Hood, Upper - Frontier (spec. colour) (incl. 23, 33, 38)
5	1	601-103	Tube, Dash Handle, Pass. Side	45	109	120-09	Rivet 3/16 x 1 - Black
6	2	100-109	Cup Holder Insert	46	8	103-48	T/S Pan HD PHIL #10 x 5/8
7	1	126-68	Plate, Operation	47	4	126-79	Bumper, Plastic - Black
8	1	707-42	Screen, Intake	48	20	108-25	Washer .31 x .75 x .06 Zn
9	1	801-03	Seat, Rear - Left - 8x8 - Black	49	4	603-15	Washer, Plastic 5/16 Hole
10	1	100-108	Mesh, Glove Box	50	2	103-08	HHCS 1/4-20 x 1.0 Zn
11	1	126-10	Wing Stud	51	1	127-144	Label, Warning - HOT
12	1	803-60	Firewall	52	1	126-60	Vinyl Strip, 1/2" x 1/4" x 37.5'
13	1	801-02	Seat, Rear - Right - 8x8 - Black	53	8	108-59	Lockwasher #10 Int. Tooth Zn
14	1	126-67	Plate, Floor Pan	54	9	103-47	HHCS 10-24 x 1/2
15	1	127-173	Plate, Vehicle Capacity	55	2	113-12	Insert, 1/2-13
16	2	127-01	Reflector, Red	56	2	108-35	Washer .53 x 1.06 x .09 Zn
17	1	803-58	Floor Pan, Rear	57	2	112-151	HHCS 1/2-13 x 1" Gr2 Zn
18	1	127-141	Label, Caution - Keyswitch	58	1	613-37	Terminal Strip, Ground
19	1	126-69	Plate, Fuel	59	17	120-13	Rivet, 3/16 x 5/8 Black
20	2	127-164	Nameplate - 8x8 Frontier 650	60	1	117-10	Locknut, 10-24 N/I Zn
21	2	601-106	Trim, Vinyl - 30" Black	61	38	120-24	Rivet, 3/32 x 3/8 Alum. (all plates)
22	1	126-09	Grommet, Alum. Flattened Half	62	2	100-114	Gasket, Drain Plug
23	1	602-53	Frame Ass'y, Hood - Front	63	3	602-56	Latch, Hood - Soft Draw
24	1	801-05	Bumper, Vinyl - 8x8	64	1	601-104	Tube, Dash Handle, Driver Side
25	1	803-59	Floor Pan, Front	65	2	112-180	Screw, Self-Drilling, #8x3/4
26	1	801-50	Body, Lower	66	1	613-123	Post, Power, 5/16-18, Red
27	2	100-107	Plug, Drain - Flanged	67	1	128-26	Grommet, 1-1/2ID x 1-3/4x1/4
28	1	104-13	Pin, Toplink - 3/4 x 2.75				
29	1	616-16	Hitch Assembly				
30	1	616-19	Tube, Hitch				
31	4	103-61	HHCS 3/8-24 x 1.5 Gr5 Zn				
32	1	104-11	Pin, Lynch - Ring				
33	2	120-15	Rivet - 1/8 x 7/16				
34	1	616-20	Gasket, Rear Hitch				
35	4	108-15	Washer .42 x .81 x .05 Zn				
36	25	120-11	Rivet 5/32 x 9/16 - Black				
37	6	120-05	Washer, .19 x .50 x .04 Zn				
38	1	602-57	Hood Kit - Frontier (spec. colour) (incl. 3, 4, 36, 53, 54, 63)				
39	2	117-44	T- Nut 1/4-20 Zn				
40	86	120-04	Washer .19 x .50 x .08 Zn				

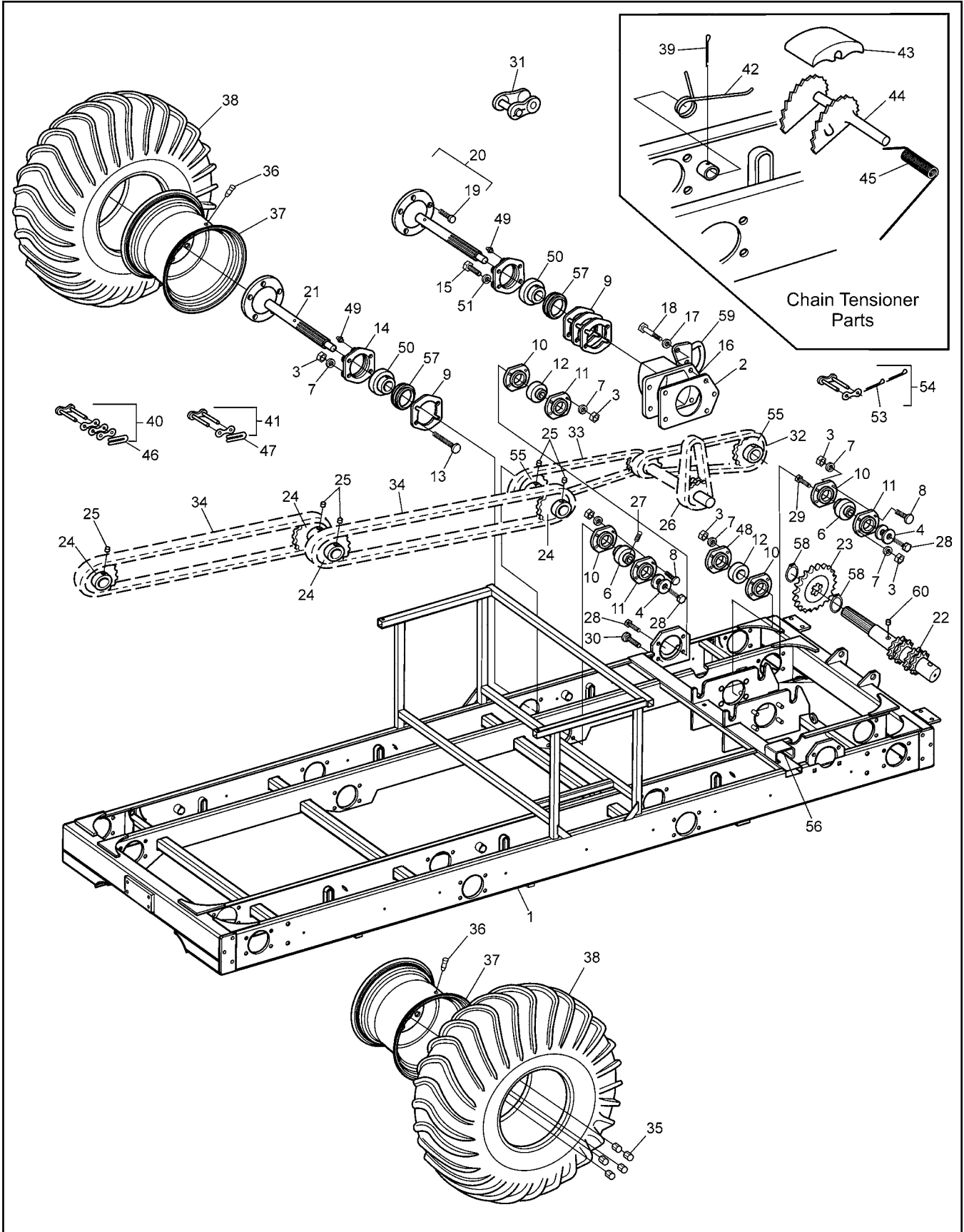

# 8x8 Frontier Parts Manual

# 8.0 Frame and Drive System

Ref.	Qty.	Part #	Description	Ref.	Qty.	Part #	Description
1	1	804-100	Frame Asm - Avenger	37	8	125-13B	Rim - 10 x 9 - Black
2	4	606-25	Gasket - Bearing Extension	38	8	127-158	Tire, Argo 24 x 10-8
3	80	117-29	Locknut, Nylon 3/8-16 Zn	39	6	100-01	Pin, Cotter 1/8 x 1.50 Zn
4	16	108-46	Washer .40 x 1.37 x .12 Hi-Carbon	40	1x4	100-96	Con. Link, RC50-2 H.D.
5	8	101-35	Bearing, Ball - 1.25	41	1x4	603-84	Con. Link, RC60-1 H.D.
6	8	101-41	Bearing, Ball - 1.0	42	6	127-65	Spring Torsion - 1.16x0.35
7	80	108-15	Washer, .42 x .81 x .05 Zn	43	6	606-44	Slider Block
8	35	103-88	C/Bolt 3/8-16 x 1.0 Gr5 Zn	44	6	606-82	Tensioner Asm, Chain
9	16	606-90	Gasket, Flange - 72mm	45	6	127-64	Spring, Torsion - .76 x 1.9
10	12	606-91	Flange - 4 Hole Hd	46	4	603-95	Spring Clip - RC 50 Closed
11	10	606-92	Flange, Greasable - 4 Hole Hd	47	4	603-96	Spring Clip - RC 60 Closed
12	4	101-96	Bearing, Ball - 1.25x1.5 No Grv	48	2	606-93	Flange, Greaseable - 90 Deg. Hd
13	16	112-187	C-Bolt 3/8-16x2.0 Gr5 Zn	49	8	100-121	Fitting, Grease 3/16"
14	8	606-87	Flange, Outer Bearing	50	8	101-95	Bearing, Ball - 1.25 x 72mm
15	16	103-68	HHCS 3/8-16 x 2.0 Gr5 Zn	51	16	108-06	Lockwasher 3/8 Split Ring Zn
16	4	810-112	Bearing Extension w/nuts	53	4	104-35	Pin, Cotter 2mm x 12mm
17	20	108-34	Washer .47 x .94 x .06 Zn	54	2	603-94	Con. Link, RC60-1 Cotter Pin
18	20	112-181	HHCS 7/16-20 x 1.75 Gr5 Zn	55	4	810-28	Sprocket, Double - 24T
19	5x8	103-80	Stud, Wheel 7/16-20 x 1.125 #B271	56	2	606-43	Slide, Chain - 2-3/4"
20	2	810-73	Axle Asm - Front/Rear (incl. Ref. 19)	57	8	606-89	Carrier, Axle Bearing
21	6	810-75	Axle Asm - Mid (incl. Ref. 19)	58	4	107-10	Retaining Ring SH-0125-PA
22	2	810-59	Shaft, Idler - 11T	59	2	642-47	Tie Down Bracket
23	2	606-72	Sprocket, Idler S60 x 21T	60	1	613-127	Magnet, Speedometer
24	8	606-34	Sprocket, S60 x 19T				
25	10	112-03	SHSS 5/16-18 x 3/8 1/2 DOG, PL				
26	2	803-62	Chain, RC60-1 x 34P Idler-Lambda				
27	2	112-60	SHSS 1/4-28 x 1/2 Cup Pt.				
28	8	112-31	HHCS 3/8-16 x 1.0 2B Gr8 Zn				
29	1	112-163	HHCS 3/8-16 x 2.0 Gr5 Zn				
30	4	112-61	C/Bolt 3/8-16 x 1.25 Gr5 Zn				
31		127-80	Link, Half - RC60 - 1 (opt.)				
32	2	803-55	Chain, RC50-2 x 46P-Front (incl. Ref. 40)				
33	2	803-56	Chain, RC50-2 x 74P-Mid (incl. Ref. 40)				
34	4	803-57	Chain, RC60-1 x 90P-Rear (incl. Ref. 41)				
35	5x8	117-35	Nut, Wheel 7/16-20 Zn				
36	8	125-26	Valve, Tire				

# 9.0 Fuel System & Seat Assembly 8x8 Frontier Parts Manual

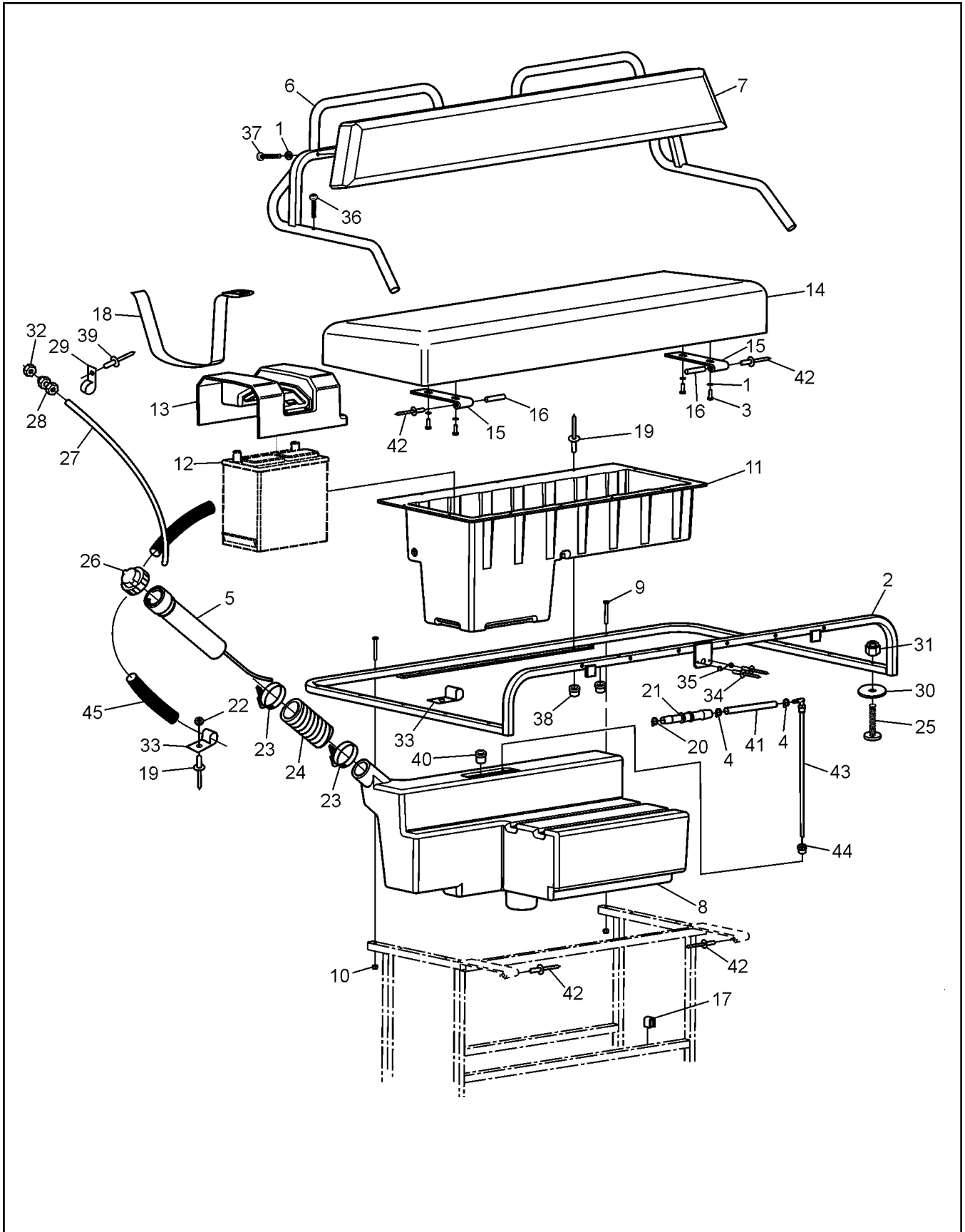

## 8x8 Frontier Parts Manual 9.0 Fuel System & Seat Assembly

Ref.	Qty.	Part #	Description
1	8	108-03	Lockwasher 1/4 Split Ring Zn
2	1	608-96	Frame Assembly, Seat
3	4	112-04	HHCS 1/4-20x3/4 Gr2 Zn
4	2	112-78	Clamp, Hose, 9/16
5	1	608-59	Neck Assembly, Vented Filler
6	1	608-76	Frame Assembly, Backrest
7	1	608-39	Back pad Assembly
8	1	608-91	Tank, Fuel - Avg
9	2	103-77	HHCS, 1/4-28 x 2.0
10	2	117-01	Locknut, Nylon 1/4-28 Zn
11	1	608-54	Toolbox
12	1	127-54	<b>See Section 10.0 Electrical System</b>
13	1	608-55	Cover, Battery
14	1	608-88	Seat Assembly, Bench - Thick
15	2	608-81	Hinge, Seat, Bolted
16	2	104-43	Pin, 3/16" x 1-1/8"
17	4	702-06	Foam Cushion
18	1	608-56	Strap, Battery
19	17	120-09	Rivet 3/16x1 - Black
20	4	112-79	Clamp, Hose, 1/2" - Black
21	1	808-133	Reducer, 5/16" to 1/4" Barbed
22	8	120-04	Washer .19 x .50 x .08 Zn
23	2	100-12	Clamp, Gear 2.25" HF-36
24	1	125-94	Hose, Filler
25	10	112-07	RHMS 10-24 x 1.50 Zn
26	1	126-46	Cap, Fuel
27	1	127-21	Hose, Vent - 109"
28	1	126-50	Male Connector, 1/4"
29	6	126-94	Clamp, Nylon Wire - 1/4" ID
30	10	108-42	Washer .21 x 1.0x.06 Zn
31	14	117-10	Locknut, Nylon #10-24 Zn
32	1	117-54	Nut, Locking PAL 1/2-20 Zn
33	7	126-93	Clamp, Nylon Wire - 1/2" ID
34	2	120-15	Rivet, 1/8 x 7/16
35	1	126-11	Spring
36	2	112-41	PHMS, Phil 1/4-20 x 1.25 Zn
37	4	103-03	PHMS, Phil 1/4-20 x 1.50 Zn
38	2	117-64	Insert, 1/4-20 Steel Cad Pltg.
39	4	120-13	Rivet, 3/16 x 5/8 Black
40	1	808-123	Plug, Nylon, 1/4 - NPT
41	2"	608-69RM	Hose, Fuel - 5/16" ID Carb
42	4	120-31	Rivet, 3/16" x 1/4, Open End
43	1	608-89	Pick-up, Fuel, 5/16 x 11.75"
44	1	608-90	Grommet, 5/16" Tube, 3/4" Hole
45	1	608-66	Hose, Fuel 1/4" ID, 80"

# 10.0 Electrical System

# 8x8 Frontier Parts Manual

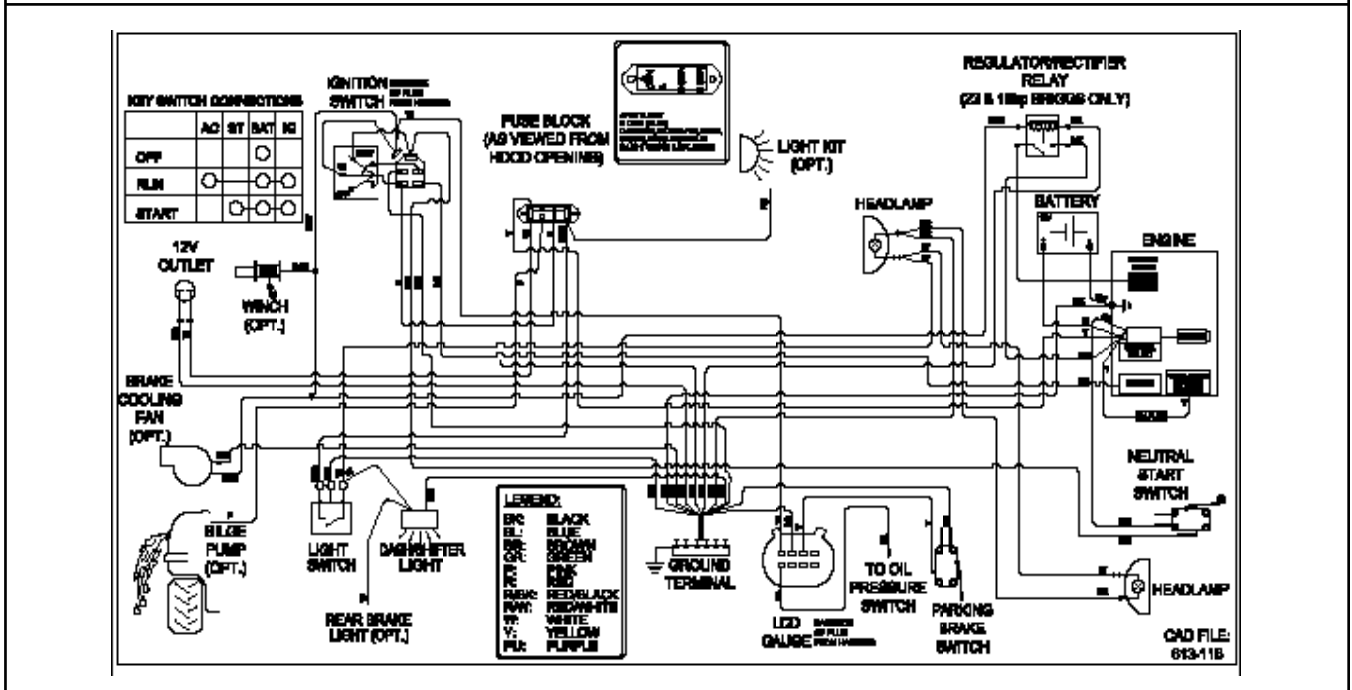
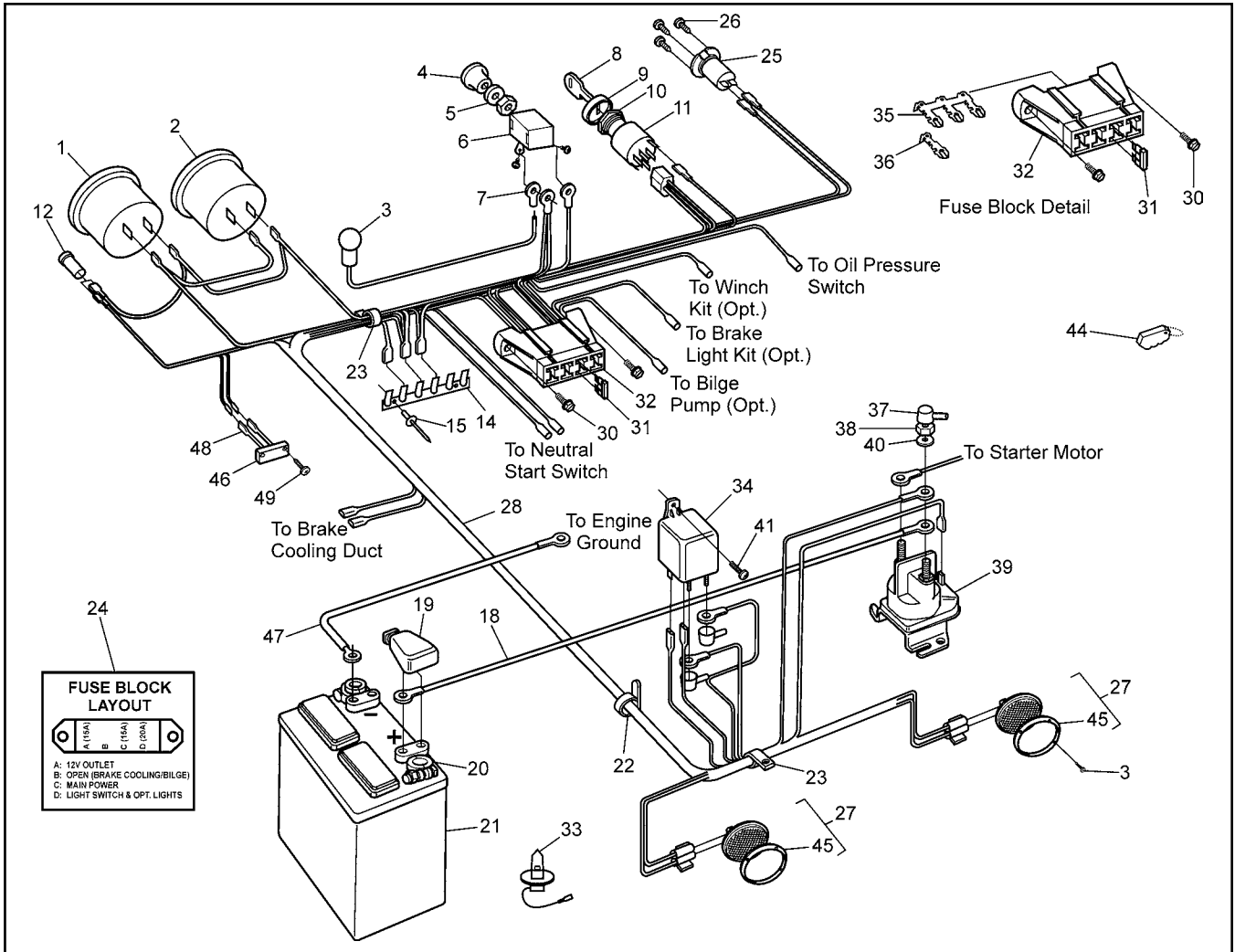

Ref.	Qty.	Part #	Description
1	1	613-121	Switch, Illuminated
2	1	100-120	Sticker, Light Switch
3	8	112-56	T/S Pan Hd Phil #10 x 3/4 Blk.
4	1	613-128	Cable, Extension, Speedo Pickup
5	1	613-126	Sensor, Speedo Pickup
6	1	613-124	Insulator, 2 Way w/cap, Red
7	1	118-30	Terminal, Eye - #10
8	2	127-108	Key, Molded
9	1	127-107	Cover, Nut
10	1	127-106	Nut, Flanged - Plastic
11	1	127-105	Switch - Ignition
12	1	117-87	Nut, M12 x 1.25, Zn
13	1	613-119	Gauge, LCD
14	1	613-37	Terminal Strip, Ground
15	2	120-15	Rivet 1/8 x 7/16
18	1	613-94	Wire, Positive Battery
19	1	127-55	Cap, Battery Terminal - Red
20	2	127-56	Terminal, Battery Post
21	1	127-54	Battery, Exide 45-60
22	8	100-64	Tie Wrap - 5.5" - Black
23	13	126-93	Clamp, Nylon Wire - 1/2" ID
24	1	127-154	Label, Fuse Panel
25	1	613-90	Outlet, 12 V DC
26	3	112-139	#4 Phil Drive Oval Head Screw, Black
27	2	613-159	Headlight Ass'y - 3.75W (incl. items 33 & 45)
28	1	613-116	Wire Harness
30	2	112-51	Screw, IHWH T/C #10-24 x 5/8
31	3	118-49	Fuse, 15 A 2-prong (AT015)
32	1	118-60	Block Fuse - 8 position (4 fuse)
33	2	127-46	Bulb, Headlight - Halogen
34	1	613-98	Relay, 80 Amp
35	1	118-63	Terminal, Fuse - Triple
36	5	118-62	Terminal, Fuse - Single
37	3	613-45	Insulator, Terminal (6 ga.)
38	3	117-20	Nut, Fin. Hex 1/4-20 Zn
39	1	613-68	Starter Relay
40	1	108-03	Lockwasher 1/4 Split Ring Zn
41	1	103-48	T/S Pan Hd Phil #10 x 5/8 A Blk
44	1	681-00	FOB, Key - Floating
45	2	613-152	Bezel, Headlamp
46	1	613-99	Light, Shifter Illumination
47	1	613-95	Wire, Negative Battery
48	2	118-69	Terminal, 3/16 Male Blade 22 Ga
49	2	112-139	OHPS T/S #4 x 5/8 Black Zn

# **ARGO** Products Manufactured by:

## **Ontario Drive & Gear Limited**

220 Bergey Court

New Hamburg, Ontario

Canada N3A 2J5

Phone: (519) 662-2840

Fax: (519) 662-2421

[www.argoatv.com](http://www.argoatv.com)

**ODG** *Dedicated to quality and performance*